

**Serie | 2, Gas hob, 60 cm, Stainless steel  
PBP6B5B80**



**Gas hob with side-mounted controls: the desired cooking zones can be conveniently operated from the side.**

- **Continuous steel pan supports:** for maximum stability.
- **Biomethane-ready:** your gas hob can also be powered with renewable biomethane gas.
- Ergonomic control knobs with raised center for precise adjustments.
- **Surface colour:** elegant stainless-steel design.

---

**Technical Data**

Product name/family : gas hob w integrated controls

Construction type : Built-in

Energy input : Gas

Total number of positions that can be used at the same time : 4

Type of control setting devices : sword knobs

Required niche size for installation (HxWxD) : 45 x 560-562 x 480-492 mm

Width of the appliance : 580 mm

Dimensions : 45 x 580 x 510 mm

Dimensions of the packed product (HxWxD) : 141 x 651 x 578 mm

Net weight : 6.097 kg

Gross weight : 7.0 kg

Residual heat indicator : without

Location of control panel : Hob lateral

Basic surface material : Stainless steel

Color of surface : Stainless steel

Color of frame : Stainless steel

Approval certificates : CE, Eurasian

Length of electrical supply cord : 100 cm

EAN code : 4242002831770

Electrical connection rating : 1 W

Gas connection rating : 7400 W

Fuse protection : 3 A

Voltage : 220-240 V

Frequency : 60; 50 Hz



4 242002 831770

## Serie | 2, Gas hob, 60 cm, Stainless steel PBP6B5B80

**Gas hob with side-mounted controls: the desired cooking zones can be conveniently operated from the side.**

---

### **Design**

- Stainless steel surface
- enamelled pan supports

### **Usage convenience**

- Design co-ordinated control dials: access knobs on the side with strong grip for effortless turning.
- Ignition via control dials: just push and turn the dials to ignite the flame.

### **Burners and power**

- 4 gas burners:
- Left front: high-speed burner up to 3 kW (depending on gas type)
- Left rear: Standard burner up to 1.7 KW (depending on gas type)
- Right rear: standard burner up to 1.7 KW (depending on gas type)
- Right front: economy burner up to 1 KW (depending on gas type)

### **Safety**

- Flame failure safety device: prevents unwanted gas flow when flame goes out.

### **Installation (gas types & measurements)**

- Usable for: Nat gas L/LL G25/20mbar(DE)  
NG H/E 20mbar, E+ 20/25mbar  
Natural gas H 25 mbar (HU)  
Natural gas L 25 mbar (NL)  
Liquid gas G30,31 28-30/37mbar  
Liquid gas G30 37 mbar (PL)  
Liquid gas 50 mbar
- Pre-set for natural gas
- Nozzle set for LPG jets included. Connection to 28-30/37 mbar bottled gas. Nozzles for all other gas types can be ordered via the customer service. For nozzle change, please contact the customer service.
- Dimensions of the product (HxWxD mm): 56 x 580 x 510
- Required niche size for installation (HxWxD mm) : 45 x 560 x (480 - 492)
- Min. worktop thickness: 30 mm

**Serie | 2, Gas hob, 60 cm, Stainless steel  
PBP6B5B80**

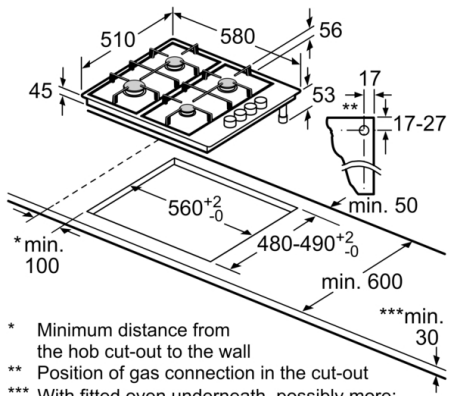

- \* Minimum distance from the hob cut-out to the wall
  - \*\* Position of gas connection in the cut-out
  - \*\*\* With fitted oven underneath, possibly more; see space requirements for the oven
- measurements in mm